

KOBELCO

SK210HLC-10E/SK210HNLC-10E

SK210H_{LC} SK210H_{NLC}

■ Bucket Capacity:

0.7 - 0.93 m³

■ Engine Power:

124 kW / 2,000 min⁻¹

■ Operating Weight:

22,100 - 23,100 kg



HYBRID

We Save You Fuel
Achieving a Low-Carbon Society



Power Meets Efficiency

In 2006, KOBELCO developed the world's first hybrid machine full hydraulic excavator in the history of hydraulic excavators.

The forerunner of the hybrid machine full hydraulic excavators was the SK80H. Then, its 20-ton class successor, the SK200H-9, achieved overwhelmingly great fuel efficiency, creating a strong image of 'fuel-efficient KOBELCO excavators'.

The SK210HLC-10E, the latest model, is equipped with not only the hybrid technology developed and nurtured by KOBELCO but also a large-capacity lithium-ion battery for the first time in the industry.

The technology of KOBELCO which knows hybrid machines well has enabled a compact but high-power assist, evolving its hybrid machines into 'genuine hybrid machines' in terms of fuel efficiency and productivity.

Furthermore, the SK210HLC-10E is equipped with newly designed extra durable devices to maintain its value.

To the new stage. The hybrid machines of KOBELCO greatly exceed the hybrid standards that KOBELCO has established.



HYBRID

5X210H

Higher fuel efficiency means 'Efficiency'

Increase in productivity means 'Power'



JAPANESE QUALITY

Into the era of 'genuine hybrid machines'



High-output engine

Equipped with an Exhaust Gas After-Treatment System and an SCR*¹ System with a DEF/Urea **NEW**

The engine exhaust system has an SCR system with a DEF/Urea that converts NOx*² emissions into harmless nitrogen and water. Combining this system with an exhaust gas after-treatment system that captures and disposes of PM*³, the SK210HLC has a much cleaner exhaust.

Nox reduction rate
(compared to the conventional model)

About **88%** decrease

*¹ SCR: Selective Catalytic Reduction

*² NOx: Nitrogen Oxide

*³ PM: Particulate Matter

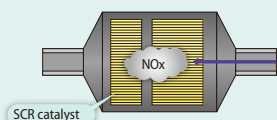

Reduces Fuel Consumption and Minimizes Exhaust Emissions

EGR Cooler Reduces NOx

Cooled exhaust gases from the EGR cooler are mixed with fresh air in the intake. The recirculated air lowers the combustion temperature, which reduces NOx.

VG Turbo Reduces PM

The variable-geometry turbocharger adjusts air intake to maximize combustion efficiency. At low engine speeds, the nozzles are closed, the turbo speed increased, and air intake is boosted. This helps lower fuel consumption.

Common Rail Fuel Injection System Reduces PM

The higher injection pressure atomizes the fuel. The combustible fuel and the improved injection timing accuracy enhance the combustion efficiency, which also contributes to the reduction of fuel consumption.

New Hybrid System **NEW**

KOBELCO's original hybrid system has further evolved. The newly adopted swing electric motor provides operability unique to a hybrid machine. Furthermore, the large generator motor driven by the large-capacity lithium-ion battery constantly assists the engine, greatly reducing the engine load. The new hybrid system effectively supports fuel efficiency and power for swing, digging, and traveling, thus realising a workload which far exceeds that of conventional machines.

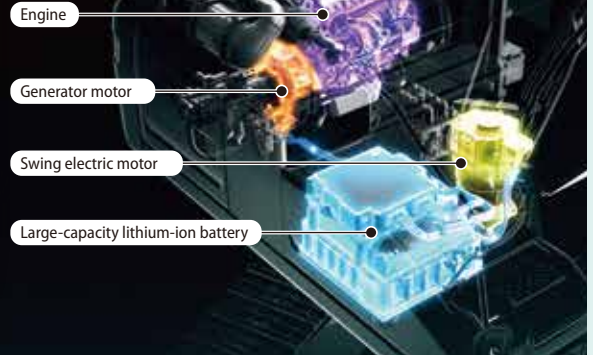

Adoption of a lithium-ion battery for the first time in the industry **NEW**

The adoption of the large-capacity lithium-ion battery reduces the size and provides mass energy storage at the same time. The battery continuously assists the hybrid machine.

Generated power **3.3** times higher

(compared to the power generated by the nickel-metal hydride batteries used in the SK80H-2)

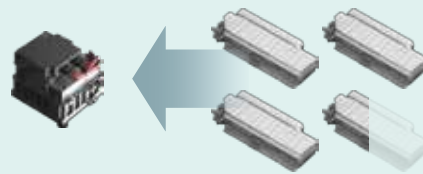

Lithium-ion battery (SK210HLC-10E)

Nickel-metal hydride battery (SK80H-2)

Runtime **17.6** times longer

(compared to that of the capacitors used in the SK200H-9)

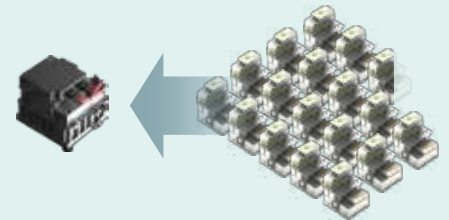

Lithium-ion battery (SK210HLC-10E)

Capacitors (SK200H-9)

Independent swing electric system enable good operability for combined operation of swing and attachment **NEW**

During swing acceleration

The swing motor is only powered by electricity accumulated in the lithium-ion battery.

During swing deceleration

The braking energy generated during swing deceleration is converted into electricity, and then the electricity is accumulated in the lithium-ion battery.



← During swing acceleration
← During swing deceleration

While the machine is digging or traveling, an assist from the generator motor greatly reduces the engine load **NEW**

During high-load operation

Assisting the engine by adding up to 25 kW

The power of the generator motor has increased to 25 kW (equivalent to the power output of the engine of a 5-ton class excavator). The electricity accumulated in the lithium-ion battery allows the generator motor to assist the engine. Thus, fuel consumption is reduced.

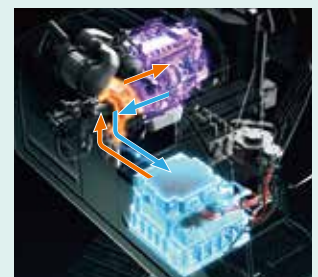

← During high-load operation
← During low-load operation

During low-load operation

The engine power is used to generate electricity in the generator motor. And then, the electricity is accumulated in the lithium-ion battery. Digging and traveling are done hydraulically.

*The warranty period of the battery, swing motor, generator motor and inverter of the hybrid system is 5 years or 10,000 hours.

More Power and Higher Efficiency

The combination of the hybrid system and a new hydraulic system realizes low fuel consumption and high efficiency at the same time. We promise you an increase in production volume with the most advanced technologies.

Superior Digging Volume

This excavator offers dynamic digging force even as it minimizes fuel consumption rates, achieving class-leading work volume. H-mode with an increased torque setting delivers about 7% greater digging volume.

■ Digging volume/hour
(Compared to H-mode on SK210LC-9)



■ Max. Bucket Digging Force

Normal: **143 kN**
With Power Boost: **157 kN**

■ Max. Arm Crowding Force

Normal: **102 kN**
With Power Boost: **112 kN**

*Values are for HD arm (2.94 m)



In Pursuit of Improved Fuel Efficiency

Fuel Efficiency

H-mode, S-mode and ECO-mode are fuel efficiency modes in which fuel consumption is reduced in comparison with the previous standard model.

■ Comparison with the conventional standard machine (SK210LC-9)

- H** mode About **13.9%** improvement
- S** mode About **16.7%** improvement
- E** ECO-mode ... About **12.1%** improvement

* The percentages are approximate improvement rates.

AIS (Auto Idle Stop)

If the boarding/disembarking lever is left up, the engine will stop automatically. This eliminates wasteful idling during standby, saving fuel and reducing CO₂ emissions as well.

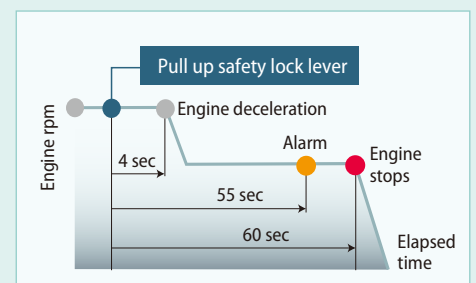



Operator-friendly Features Include Controls that Are Easy to See, Easy to Use

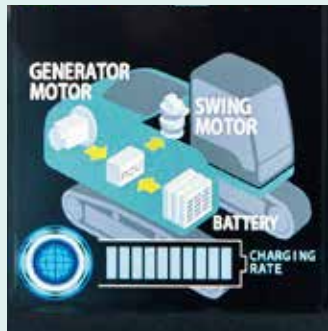

Power supply monitor screen



Maintenance



Fuel consumption

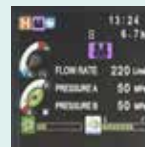

Nibbler mode

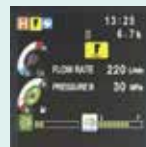

Breaker mode

Multi-Display in Color

Brilliant colors and graphic displays are easy to recognize on the LCD multi-display in the console. The display shows fuel consumption, maintenance intervals, and more.



- 1 Analog gauge provides an intuitive reading of fuel level and engine water temperature
- 2 Green indicator light shows low fuel consumption during operation
- 3 PM accumulation display (left)/Urea level gauge (right)
- 4 Switches between power supply monitor, fuel consumption, and rear view camera image
- 5 Digging mode switch
- 6 Monitor display switch

One-Touch Attachment Mode Switch

A simple flick of a switch converts the hydraulic circuit and flow amount to match attachment changes. Icons help the operator to confirm the proper configuration at a glance.

Hydraulic System: Revolutionary Technology Saves Fuel

Arm Interflow System **NEW**

When lowering the boom, this system uses the downward force generated by the boom's weight to push fluid to the shovel arm. This greatly reduces the need to apply power from outside the system.

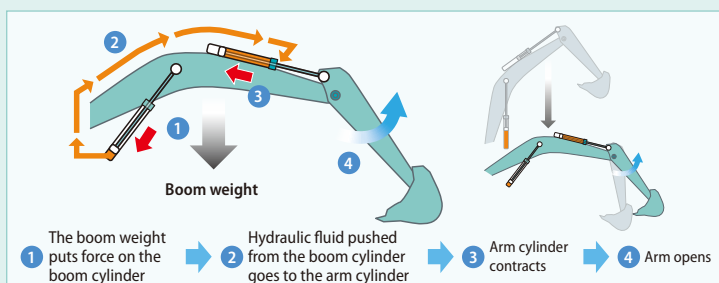

Hydraulic circuit reduces energy loss

We have made every effort to enhance fuel efficiency by minimizing hydraulic pressure resistance, improving the hydraulic line layout to control friction resistance loss and minimizing valve resistance.

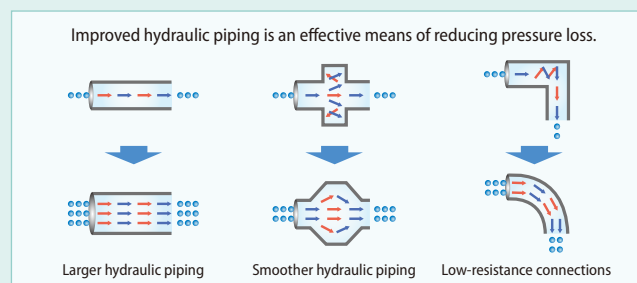

KOMEXS

KOBELCO MONITORING EXCAVATOR SYSTEM

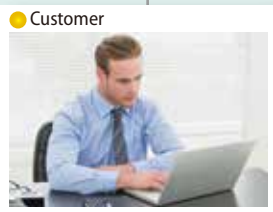

Remote Monitoring for Peace of Mind

KOMEXS (Kobelco Monitoring Excavator System) uses satellite communication and internet to relay data, and therefore can be deployed in areas where other forms of communication are difficult. When a hydraulic excavator is fitted with this system, data on the machine's operation, such as operating hours, location, fuel consumption, and maintenance status can be obtained remotely.

Direct Access to Operational Status

Location Data

Accurate location data can be obtained even from sites where communications are difficult.

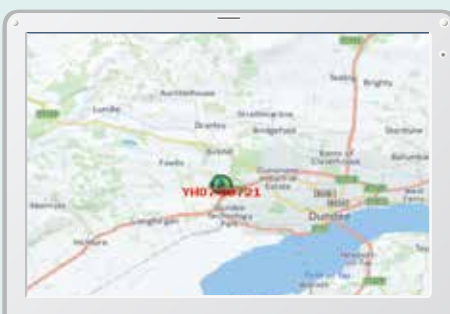

Latest location



Location records

Type of Operation		Working Hrs	Ratio
Total Working Hrs		169 Hrs	100 %
Digging Hrs		72.2 Hrs	43 %
Traveling Hrs		18.3 Hrs	11 %
Idle Hrs		15.9 Hrs	9 %
Opt Att Hrs		62.5 Hrs	37 %
Crane Mode Hrs		0 Hrs	0 %

Work data

Operating Hours

- A comparison of operating times of machines at multiple locations shows which locations are busier and more profitable.
- Operating hours on site can be accurately recorded, for running time calculations needed for rental machines, etc.

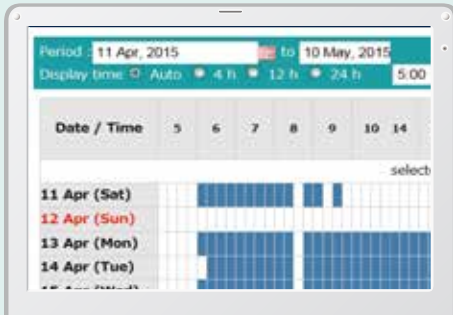

Daily report

Fuel Consumption Data

Data on fuel consumption and idling times can be used to indicate improvements in fuel consumption.

Work mode	Working Hrs	Total Fuel Consumption
H mode	2:06	24.5 L
S mode	0:00	0.0 L
E mode	169:19	1489.7 L
TOTAL	171:25	1514.2 L

Fuel consumption

Graph of Work Content

The graph shows how working hours are divided among different operating categories, including digging, idling, traveling and optional operations.

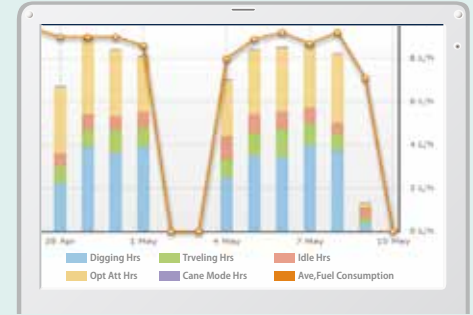

Work status

Maintenance Data and Warning Alerts

Machine Maintenance Data

- Provides maintenance status of separate machines operating at multiple sites.
- Maintenance data is also relayed to KOBELCO service personnel, for more efficient planning of periodic servicing.

Model	Serial No.	Hour Meter	Engine Oil
SK135SRLC-3/SK140SRL	YH07-09721	734 Hr	434
SK135SRLC-3/SK140SRL	YH07-09789	73 Hr	429
SK210LC-9	YQ13-10454	960 Hr	58
SK210LC-9	YQ13-10481	549 Hr	498
SK75SR-	YTD8-20374		

Maintenance

Warning Alerts

This system warns an alert if an anomaly is sensed, preventing damage that could result in machine downtime.

Alarm Information Can Be Received through E-mail

Alarm information or maintenance notice can be received through E-mail, using a computer or cell phone.



Alarm messages can be received on mobile device.

Daily/Monthly Reports

Operational data downloaded onto a computer helps in formulating daily and monthly reports.

Security System

Engine Start Alarm

The system can be set as an alarm if the machine is operated outside designated time.

Engine start alarm outside prescribed work time

Area Alarm

It can be set as an alarm if the machine is moved out of its designated area to another location.

Alarm for outside of reset area

Increase in productivity means 'Power'



Improved Filtration System Reliability

Clean, contaminant-free fuel and hydraulic fluid are essential to stable performance. The improved filtration systems reduce the risk of mechanical trouble and enhance longevity and durability.

Fuel Filter

The pre-filter, with built-in water separator, maximizes filtering performance.

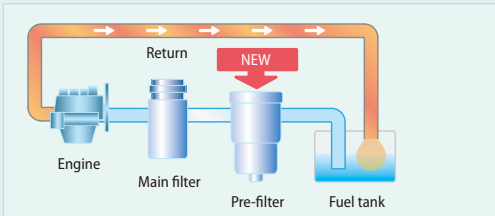

Hydraulic Fluid Filter

Recognized as the best in the industry, our super-fine filter separates out even the smallest particles. The new cover prevents contamination when changing filters.



Long-life hydraulic oil:
5,000 hours

Replacement cycle:
1,000 hours

Long-Interval Maintenance

Long-life hydraulic oil reduces cost and labor.

Highly Durable Super-fine Filter

The high-capacity hydraulic oil filter incorporates glass fiber with superior cleaning power and durability.

Double-Element Air Cleaner

The large-capacity element features a double-filter structure that keeps the engine running clean even in industrial environments.



Hydraulic Fluid Filter Clog Detector

Pressure sensors at the inlet and outlet of the hydraulic fluid filter monitor differences in pressure to determine the degree of clogging. If the difference in pressure exceeds a predetermined level, a warning appears on the multi-display, so any contamination can be removed from the filter before it reaches the hydraulic fluid reservoir.

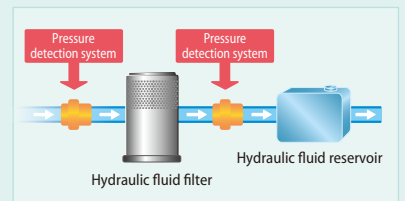

Built to Operate in Tough Working Environments

The attachment has been reinforced to handle a higher work volume, with greater power and excellent durability that can withstand demanding work conditions.

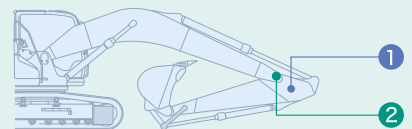

1 Enlarged Reinforcement of the Arm Foot NEW

HD: Base plate thickness has been increased 1.3 times (20 t).



2 Modified Foot Boss Shape NEW

The arm foot boss shape has been modified and improved to distribute stress, delivering 2.6 times more strength for tasks like digging next to a wall.

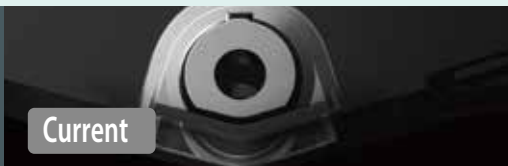

Efficient Maintenance Keeps the Machine in Peak Operating Condition



Machine Information Display Function

Examples of displaying maintenance information

- Displays only the maintenance information that's needed, when it's needed
- Self-diagnostic function provides early-warning detection and display of electrical system malfunctions
- Service-diagnostic function makes it easier to check the status of the machine
- Record function of previous breakdowns including irregular and transient malfunctions

Easy, On-the-Spot Maintenance **NEW**

There is ample space in the engine compartment for a mechanic to do maintenance work inside. The distance between steps is lower so entry and exit is easier. And the mechanic can work in comfort, without contortions or unnatural body positions. Finally, the hood is lighter and easier to raise and lower.



Generous space for maintenance work



Step/Hand rail



DEF/Urea tank

Positioned where the step opens

Maintenance Work, Daily Checks, Etc., Can Be Done from Ground Level

The layout allows for easy access from the ground for many daily checks and regular maintenance tasks.



Left side



Fuel filter/Pre-filter

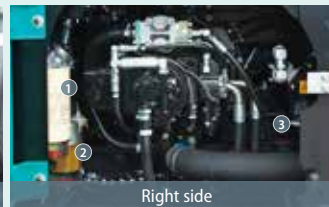

Right side

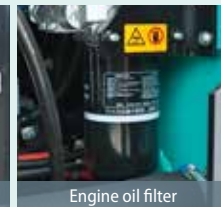

Engine oil filter



Double-element air cleaner

Laid out for easy access to radiator and cooling system elements.

① Fuel filter ② Pre-filter ③ Engine oil filter

More Efficient Maintenance Inside the Cab



Air conditioner filters



DPF reactivation switch

Internal and external air conditioner filters can be easily removed without tools for cleaning.

If the monitor warning goes off, the filter should be reactivated manually using a switch.

Easy Cleaning

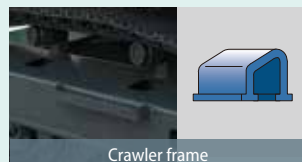

Crawler frame



Detachable two-piece floor mat

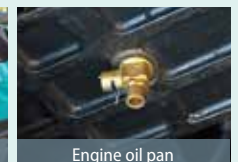

Engine oil pan

Special crawler frame design is easily cleaned of mud.

Detachable two-piece floor mat with handles for easy removal. A floor drain is located under the floor mat.

Engine oil pan equipped with a drain valve.

Comfortable Cab Is Now Safer than Ever

A work environment that is quieter and more comfortable. A cab that puts the operator first is key to improved safety.



Comfort

Super-Airtight Cab



The high level of air-tightness keeps dust out of the cab.

Quiet Inside

The high level of air-tightness ensures a quiet, comfortable cabin interior.

Low Vibration

Coil springs absorb small vibrations, and high suspension mounts filled with silicone oil reduce heavy vibration. The long stroke achieved by this system provides excellent protection from vibration.

Twice the stroke of a conventional mount

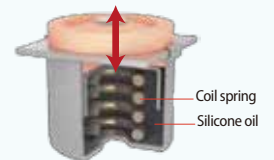

Broad View Liberates the Operator

The front window features one large piece of glass without a center pillar on the right side for a wide, unobstructed view.

Air Conditioner Register behind the Seat **NEW**



The large air-conditioner has registers on the back pillars that blow from behind and to the right and left of the operator's seat. They can be adjusted to put a direct flow of cool/warm air on the operator, which means a more comfortable operating environment.

More Comfortable Seat Means Higher Productivity



Large Cab Is Easy to Get in and out of

The expanded cab provides plenty of room for a large door, more headroom and smoother entry and exit.

Interior Equipment Adds to Comfort and Convenience



Safety

ROPS Cab

ROPS (Roll-Over-Protective Structure)-compliant cab clears ISO standards (ISO-12117-2: 2008) and ensures greater safety for the operator should the machine tip over.



Expanded Field of View for Greater Safety



Right Side Camera Fitted as Standard

Further to the existing rear-view camera, a camera for the right side is fitted as standard for easy safety checks all round the machine.

Rear view shows the area directly behind the cab.



Engine

Model	J05EVA-KSDM
Type	Direct injection, water-cooled, 4-cycle diesel engine with turbocharger, intercooler
No. of cylinders	4
Bore and stroke	112 mm x 130 mm
Displacement	5.123 L
Rated power output	119 kW/2,000 min ⁻¹ (ISO 9249)
	124 kW/2,000 min ⁻¹ (ISO 14396)
Max. torque	640 N·m/1,600 min ⁻¹ (ISO 9249)
	660 N·m/1,600 min ⁻¹ (ISO 14396)



Hybrid System Unit

Main power supply	Type	Lithium-ion battery
	Voltage	567 V
Generator motor	Type	Three-phase AC synchronous permanent magnet type
	Voltage	25 kW/1,880 min ⁻¹
Swing motor	Type	Three-phase AC synchronous permanent magnet type
	Voltage	26 kW/3,600 min ⁻¹



Hydraulic System

Pump	
Type	Two variable displacement pumps + one gear pump
Max. discharge flow	2 x 245 L/min, 1 x 21 L/min
Relief valve setting	
Boom, arm and bucket	34.3 MPa {350 kgf/cm ² }
Power Boost	37.8 MPa {385 kgf/cm ² }
Travel circuit	34.3 MPa {350 kgf/cm ² }
Control circuit	5.0 MPa {50 kgf/cm ² }
Pilot control pump	Gear type
Main control valve	8-spool
Oil cooler	Air cooled type



Swing System

Parking brake	Wet multiple plate operated automatically
Swing speed	12.7 min ⁻¹ {rpm}
Swing torque	71.5 kN·m
Tail swing radius	2,910 mm
Min. front swing radius	3,550 mm



Attachments

Backhoe bucket and combination

Type	Backhoe bucket		
Bucket capacity	SAE heaped	m ³ (cu yd)	0.70 (0.92)
	SAE Struck	m ³ (cu yd)	0.52 (0.68)
Opening width	With side cutter	mm	1,080
	Without side cutter	mm	980
No. of teeth			5
Can be turned over	2.4 m/3.5 m arm		Yes
	2.94 m arm		No
Bucket weight		kg	630
Combination	2.4 m short arm		○
	2.94 m standard arm		○
	3.5 m long arm		◎
			△

◎ Standard combination ○ General operation △ Light operation



Travel System

Travel motors	2 x axial-piston, two-step motors
Travel brakes	Hydraulic brake per motor
Parking brakes	Oil disc brake per motor
Travel shoes	49 each side
Travel speed	6.0/3.6 km/h
Drawbar pulling force	227 kN (ISO 7464)
Gradeability	70 % {35°}



Cab & Control

Cab	
All-weather, sound-suppressed steel cab mounted on the high suspension mounts filled with silicone oil and equipped with a heavy, insulated floor mat.	
Control	
Two hand levers and two foot pedals for travel	
Two hand levers for excavating and swing	
Electric rotary-type engine throttle	
Noise levels	
External	100 dB(A) (ISO 6395)
Operator	66 dB(A) (ISO 6396)



Boom, Arm & Bucket

Boom cylinders	120 mm x 1,355 mm
Arm cylinder	135 mm x 1,558 mm
Bucket cylinder	120 mm x 1,080 mm



Refilling Capacities & Lubrications

Fuel tank	320 L
Cooling system	19 L
Engine oil	20.4 L
Travel reduction gear	2 x 5 L
Swing reduction gear	5 L
Hydraulic oil tank	140 L tank oil level
	244 L hydraulic system
DEF/Urea tank	34 L



Working Ranges

Unit: m

Range	Arm	5.65 m Boom		
		Short 2.4 m	Standard 2.94 m	Long 3.5 m
a- Max. digging reach		9.42	9.9	10.34
b- Max. digging reach at ground level		9.24	9.73	10.17
c- Max. digging depth		6.16	6.7	7.26
d- Max. digging height		9.51	9.72	9.75
e- Max. dumping clearance		6.68	6.91	6.97
f- Min. dumping clearance		2.98	2.43	1.87
g- Max. vertical wall digging depth		5.57	6.1	6.47
h- Min. swing radius		3.56	3.55	3.48
i- Horizontal digging stroke at ground level		4.08	5.27	6.08
j- Digging depth for 2.4 m (8') flat bottom		5.95	6.52	7.08
Bucket capacity ISO heaped m ³		0.93	0.8	0.7

Digging Force (ISO 6015)

Unit: kN

Arm length	Short 2.4 m	Standard 2.94 m	Long 3.5 m
Bucket digging force	143 157*	143 157*	143 157*
Arm crowding force	121 133*	102 112*	91.8 101*

*Power Boost engaged.

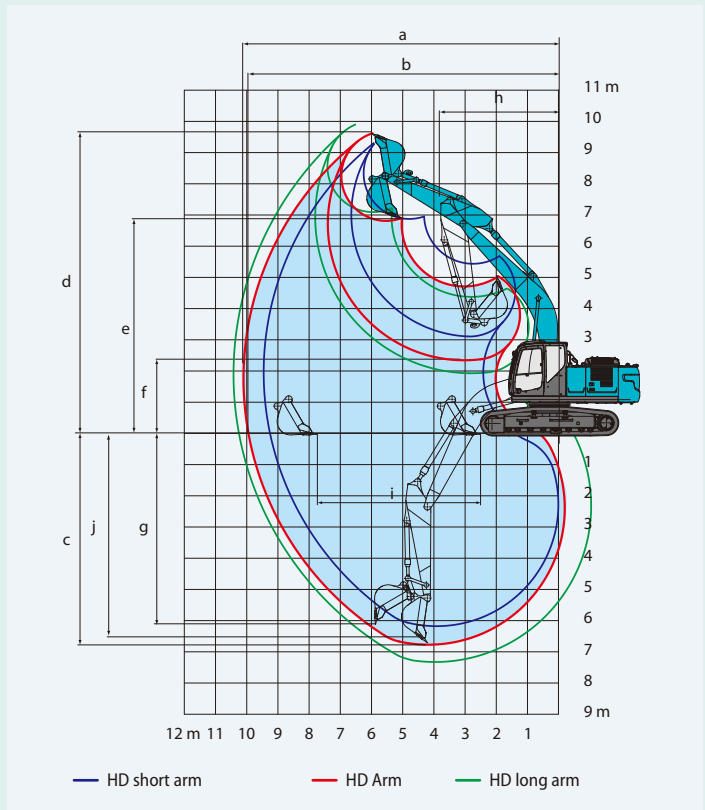

Dimensions

Arm length		Short 2.4 m	Standard 2.94 m	Long 3.5 m
A Overall length		9,680	9,600	9,670
B Overall height (to top of boom)		3,200	3,030	3,210
C Overall width of crawler	SK210HLC	2,990		
	SK210HNLC	2,800		
D Overall height (to top of cab)		3,060		
E Ground clearance of rear end*		1,060		
F Ground clearance*		450		

		Unit: mm
G Tail swing radius		2,910
G' Distance from center of swing to rear end		2,900
H Tumbler distance		3,660
I Overall length of crawler		4,450
J Track gauge	SK210HLC	2,390
	SK210HNLC	2,200
K Shoe width		600
L Overall width of upperstructure		2,710

*Without including height of shoe

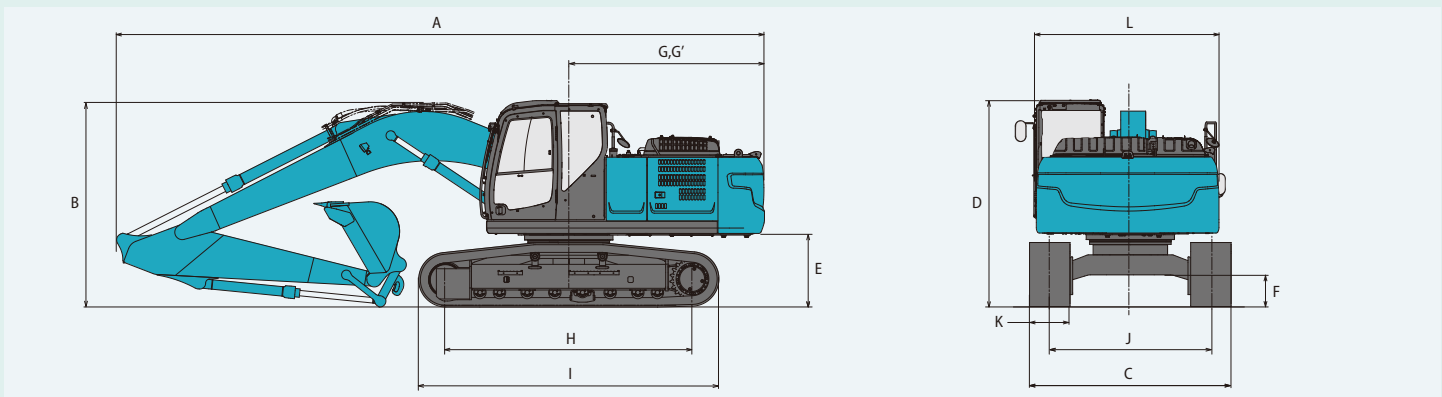

Operating Weight & Ground Pressure

In standard trim, with standard boom, 2.94 m arm, and 0.8 m³ ISO heaped bucket

Shaped	Triple grouser shoes (even height)					
		mm	700	790	900*	
Shoe width		600	700	790	900*	
Overall width of crawler	SK210HLC	mm	2,990	3,090	3,180	3,290
	SK210HNLC	mm	2,800	2,900	2,990	—
Ground pressure	SK210HLC	kPa	49	43	39	34
	SK210HNLC	kPa	49	43	39	—
Operating weight	SK210HLC	kg	22,100	22,600	22,800	23,100
	SK210HNLC	kg	22,100	22,500	22,800	—

*Only for LC version

Lift Capacities

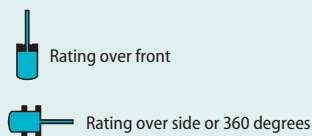
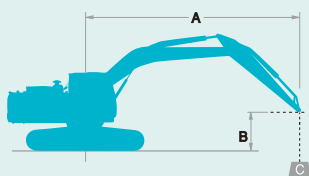

A: Reach from swing centerline to arm top
 B: Arm top height above/below ground
 C: Lifting capacities in Kilograms
 Bucket: Without bucket
 Relief valve setting: 37.8 MPa (385 kgf/cm²)

SK210HLC		Boom: 5.65 m Arm: 2.94 m Bucket: without Shoe: 600 mm (Heavy Lift)												
A \ B		1.5 m		3.0 m		4.5 m		6.0 m		7.5 m		At Max. Reach		Radius
7.5 m	kg							*5,320	*5,320			*4,280	*4,280	6.26 m
6.0 m	kg							*5,900	5,440			*3,960	3,830	7.36 m
4.5 m	kg							*6,440	5,250	5,660	3,670	*3,870	3,250	8.03 m
3.0 m	kg					*9,380	7,620	*7,300	4,970	5,530	3,550	*3,950	2,960	8.38 m
1.5 m	kg					*11,070	7,050	7,550	4,700	5,380	3,410	*4,180	2,860	8.45 m
G.L.	kg			*6,350	*6,350	11,610	6,740	7,330	4,510	5,270	3,310	4,600	2,910	8.25 m
-1.5 m	kg	*6,710	*6,710	*11,070	*11,070	11,510	6,660	7,240	4,430	5,250	3,290	5,020	3,160	7.75 m
-3.0 m	kg	*11,740	*11,740	*14,690	13,150	*10,580	6,740	7,300	4,480			5,990	3,750	6.89 m
-4.5 m	kg			*10,900	*10,900	*7,990	7,000					*6,010	5,300	5.50 m

SK210HLC		Boom: 5.65 m Arm: 3.5 m Bucket: without Shoe: 600 mm (Heavy Lift)												
A \ B		1.5 m		3.0 m		4.5 m		6.0 m		7.5 m		At Max. Reach		Radius
7.5 m	kg											*3,670	*3,670	6.84 m
6.0 m	kg									*4,570	3,770	*3,460	3,450	7.86 m
4.5 m	kg							*5,860	5,320	*5,460	3,690	*3,420	2,960	8.49 m
3.0 m	kg			*12,890	*12,890	*8,510	7,790	*6,780	5,020	5,540	3,550	*3,520	2,710	8.82 m
1.5 m	kg			*7,270	*7,270	*10,410	7,140	7,570	4,710	5,370	3,390	*3,740	2,610	8.89 m
G.L.	kg			*7,750	*7,750	*11,540	6,720	7,300	4,470	5,230	3,260	*4,140	2,640	8.70 m
-1.5 m	kg	*6,590	*6,590	*10,980	*10,980	11,410	6,560	7,170	4,350	5,160	3,200	4,530	2,830	8.22 m
-3.0 m	kg	*10,500	*10,500	*15,850	12,840	*11,020	6,580	7,160	4,350			5,270	3,280	7.42 m
-4.5 m	kg	*15,610	*15,610	*12,720	*12,720	*9,110	6,770	*6,440	4,510			*6,130	4,360	6.16 m

SK210HLC		Boom: 5.65 m Arm: 2.4 m Bucket: without Shoe: 600 mm (Heavy Lift)										
A \ B		3.0m		4.5 m		6.0 m		7.5 m		At Max. Reach		Radius
7.5 m	kg									*6,340	5,990	5.58 m
6.0 m	kg					*6,490	5,350			*5,770	4,310	6.80 m
4.5 m	kg			*8,280	8,070	*6,950	5,170	5,600	3,610	5,570	3,590	7.52 m
3.0 m	kg			*10,120	7,440	*7,720	4,910	5,500	3,520	5,070	3,250	7.89 m
1.5 m	kg			*11,550	6,940	7,500	4,670	5,380	3,420	4,920	3,130	7.97 m
G.L.	kg			11,580	6,730	7,330	4,510	5,310	3,350	5,070	3,210	7.75 m
-1.5 m	kg	*11,460	*11,460	*11,420	6,710	7,290	4,480			5,610	3,540	7.22 m
-3.0 m	kg	*13,180	*13,180	*9,900	6,850	*7,210	4,600			*6,610	4,340	6.29 m
-4.5 m	kg			*6,250	*6,250					*5,720	*5,720	4.72 m

SK210HNLC		Boom: 5.65 m Arm: 2.94 m Bucket: without Shoe: 600 mm (Heavy Lift)												
A \ B		1.5 m		3.0 m		4.5 m		6.0 m		7.5 m		At Max. Reach		Radius
7.5 m	kg							*5,320	5,020			*4,280	*4,280	6.26 m
6.0 m	kg							*5,900	5,010			*3,960	3,510	7.36 m
4.5 m	kg							*6,440	4,820	5,650	3,360	*3,870	2,980	8.03 m
3.0 m	kg					*9,380	6,930	*7,300	4,550	5,510	3,240	*3,950	2,700	8.38 m
1.5 m	kg					*11,070	6,380	7,530	4,280	5,370	3,110	*4,180	2,600	8.45 m
G.L.	kg			*6,350	*6,350	11,590	6,080	7,310	4,090	5,260	3,020	4,590	2,650	8.25 m
-1.5 m	kg	*6,710	*6,710	*11,070	*11,070	11,490	6,000	7,230	4,020	5,240	2,990	5,010	2,870	7.75 m
-3.0 m	kg	*11,740	*11,740	*14,690	11,600	*10,580	6,070	7,280	4,070			5,980	3,420	6.89 m
-4.5 m	kg			*10,900	*10,900	*7,990	6,330					*6,010	4,820	5.50 m

SK210HNLC		Boom: 5.65 m		Arm: 3.5 m		Bucket: without		Shoe: 600 mm (Heavy Lift)								
B	A	1.5 m		3.0 m		4.5 m		6.0 m		7.5 m		At Max. Reach	Radius			
7.5 m	kg											*4,570	3,460	*3,670	*3,670	6.84 m
6.0 m	kg											*5,460	3,390	*3,460	3,170	7.86 m
4.5 m	kg								*5,860	4,890	5,530	3,250	*3,420	2,710	8.49 m	
3.0 m	kg				*12,890	*12,890	*8,510	7,090	*6,780	4,590	5,350	3,090	*3,520	2,470	8.82 m	
1.5 m	kg				*7,270	*7,270	*10,410	6,460	7,550	4,290	5,210	2,960	*3,740	2,370	8.89 m	
G.L.	kg				*7,750	*7,750	*11,540	6,060	7,290	4,060	5,150	2,900	*4,140	2,390	8.70 m	
-1.5 m	kg	*6,590	*6,590	*10,980	*10,980	11,380	5,900	7,150	3,940				4,520	2,570	8.22 m	
-3.0 m	kg	*10,500	*10,500	*15,850	11,300	*11,020	5,920	7,150	3,940				5,260	2,980	7.42 m	
-4.5 m	kg	*15,610	*15,610	*12,720	11,660	*9,110	6,100	*6,440	4,100				*6,130	3,960	6.16 m	

SK210HNLC		Boom: 5.65 m		Arm: 2.4 m		Bucket: without		Shoe: 600 mm (Heavy Lift)					
B	A	3.0 m		4.5 m		6.0 m		7.5 m		At Max. Reach		Radius	
7.5 m	kg									*6,340	5,510	5.58 m	
6.0 m	kg					*6,490	4,920			*5,770	3,960	6.80 m	
4.5 m	kg				*8,280	7,370	*6,950	4,750	5,580	3,310	5,550	3,290	7.52 m
3.0 m	kg				*10,120	6,750	*7,720	4,490	5,490	3,220	5,060	2,970	7.89 m
1.5 m	kg				*11,550	6,270	7,490	4,250	5,370	3,120	4,910	2,860	7.97 m
G.L.	kg				11,560	6,060	7,310	4,100	5,300	3,050	5,060	2,920	7.75 m
-1.5 m	kg	*11,460	*11,460	*11,420	6,050	7,280	4,070				5,600	3,220	7.22 m
-3.0 m	kg	*13,180	*11,810	*9,900	6,180	*7,210	4,180				*6,610	3,960	6.29 m
-4.5 m	kg			*6,250	*6,250						*5,720	*5,720	4.72 m

Notes:

- Do not attempt to lift or hold any load that is greater than these lift capacities at their specified lift point radius and heights. Weight of all accessories must be deducted from the above lift capacities.
- Lift capacities are based on machine standing on level, firm, and uniform ground. User must make allowance for job conditions such as soft or uneven ground, out of level conditions, side loads, sudden stopping of loads, hazardous conditions, experience of personnel, etc.
- Arm top defined as lift point.
- The above lifting capacities are in compliance with ISO 10567. They do not exceed 87% of hydraulic lifting capacity or 75% of tipping load. Lifting capacities marked with an asterisk (*) are limited by hydraulic capacity rather than tipping load.
- Operator should be fully acquainted with the Operator's and Maintenance Instructions before operating this machine. Rules for safe operation of equipment should be adhered to at all times.
- Lift capacities apply to only machine as originally manufactured and normally equipped by KOBELCO CONSTRUCTION MACHINERY CO., LTD.

2 Piece Boom Specifications

Working Ranges

Unit: m

Range	Boom	Arm	3.16 m + 2.63 m		
			Short 2.4 m	Standard 2.94 m	Long 3.5 m
a-Max. digging reach			9.57	10.07	10.53
b-Max. digging reach at ground level			9.39	9.9	10.37
c-Max. digging depth			5.89	6.42	6.93
d-Max. digging height			10.83	11.23	11.5
e-Max. dumping clearance			7.95	8.35	8.62
f-Min. dumping clearance			1.51	0.97	0.41
g-Max. vertical wall digging depth			5.08	5.58	6.02
h-Min. swing radius			2.76	2.55	2.72
i-Horizontal digging stroke at ground level			5.77	6.8	7.8
j-Digging depth for 2.4 m (8') flat bottom			5.78	6.31	6.83
Bucket capacity ISO heaped m ³			0.93	0.8	0.7

Unit: kN

Arm length	Short 2.4 m	Standard 2.94 m	Long 3.5 m
Bucket digging force	143 157*	143 157*	143 157*
Arm crowding force	121 133*	102 112*	91.8 101*

*Power Boost engaged.

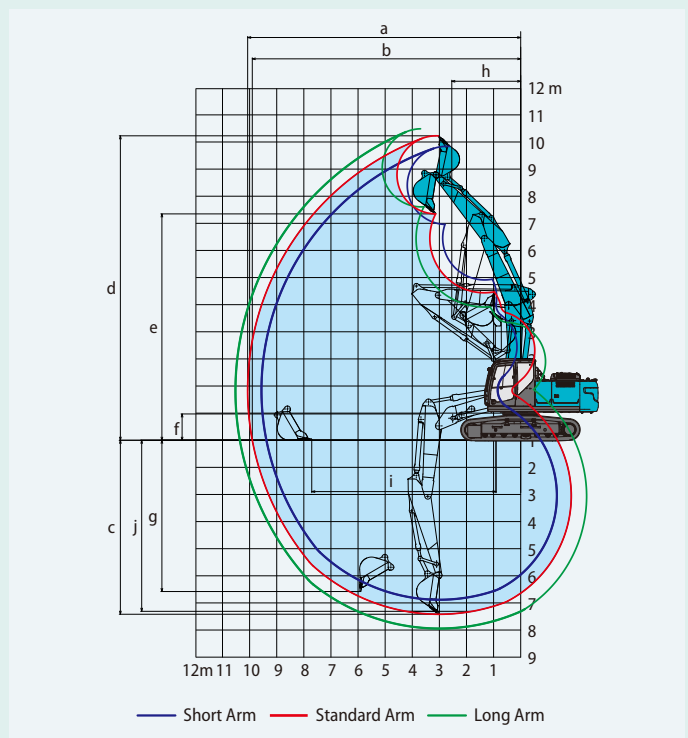



Dimensions

Arm length		Short 2.4 m	Standard 2.94 m	Long 3.5 m
A	Overall length	9,760	9,740	9,730
B	Overall height (to top of boom)	3,030	2,970	3,280
C	Overall width of crawler	SK210HLC	2,990	
		SK210HNLC	2,800	
D	Overall height (to top of cab)	3,060		
E	Ground clearance of rear end*	1,060		
F	Ground clearance*	450		
G	Tail swing radius	2,910		
G'	Distance from center of swing to rear end	2,900		
H	Tumbler distance	3,660		
I	Overall length of crawler	4,450		
J	Track gauge	SK210HLC	2,390	
		SK210HNLC	2,200	
K	Shoe width	600		
L	Overall width of upperstructure	2,710		

*Without including height of shoe

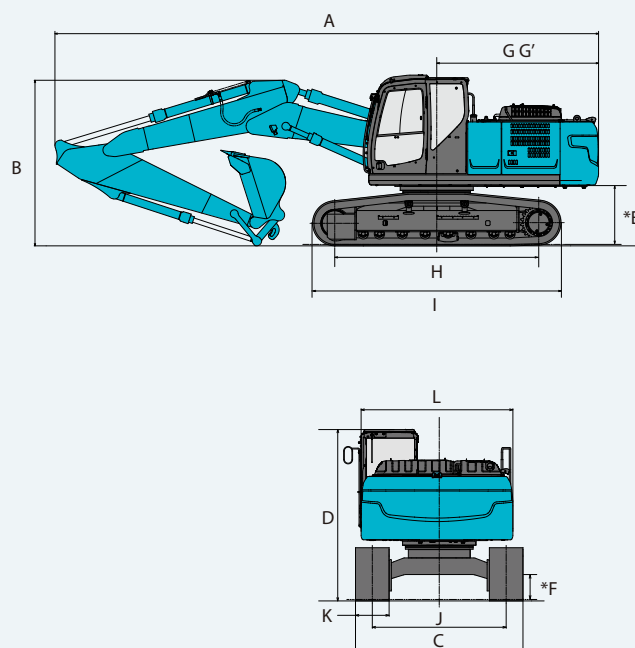

Operating Weight & Ground Pressure

In standard trim, with two piece boom, 2.94 m arm, and 0.8 m³ ISO heaped bucket

Shape		Triple grouser shoes (even height)				
Shoe width	mm	600	700	790	900*	
Overall width	mm	SK210HLC	2,990	3,090	3,180	3,290
		SK210HNLC	2,800	2,900	2,990	-
Ground pressure	kPa	SK210HLC	52	45	41	36
		SK210HNLC	52	45	41	-
Operating weight	kg	SK210HLC	23,100	23,500	23,700	24,000
		SK210HNLC	23,000	23,400	23,700	-

*Only for LC version

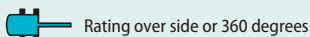
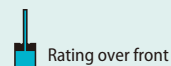
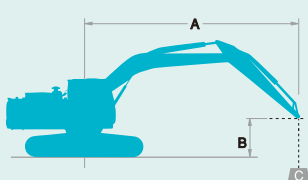

A: Reach from swing centerline to arm top
 B: Arm top height above/below ground
 C: Lifting capacities in Kilograms
 Bucket: Without bucket
 Relief valve setting: 37.8 MPa (385 kgf/cm²)

SK210HLC		Boom: 2 piece boom		Arm: 2.94 m		Bucket: without		Shoe: 600 mm (Heavy Lift)		At Max. Reach		Radius		
A		1.5 m		3.0 m		4.5 m		6.0 m		7.5 m				
B														
9.0 m	kg					*5,890	*5,890					*4,940	*4,940	4.74 m
7.5 m	kg					*6,780	*6,780	*5,690	5,430			*4,050	*4,050	6.49 m
6.0 m	kg					*6,880	*6,880	*4,630	*4,630	*4,110	3,600	*3,710	3,540	7.55 m
4.5 m	kg			*10,470	*10,470	*9,190	8,200	*7,640	5,160	*4,830	3,550	*3,590	3,000	8.21 m
3.0 m	kg	*31,530	*31,530	*16,390	14,190	*10,820	7,420	7,780	4,820	*4,790	3,400	*3,620	2,720	8.55 m
1.5 m	kg			*17,880	12,650	*11,570	6,740	7,410	4,490	*5,150	3,240	*3,780	2,620	8.62 m
G.L.	kg	*19,960	*19,960	*14,880	12,260	*11,210	6,390	7,160	4,270	5,140	3,130	*4,120	2,670	8.42 m
-1.5 m	kg			*10,010	*10,010	*9,840	6,310	7,070	4,190	5,120	3,110	*4,700	2,900	7.93 m
-3.0 m	kg			*8,610	*8,610	*7,450	6,430	*5,650	4,260			*3,790	3,460	7.10 m
-4.5 m	kg			*11,930	*11,930	*6,740	*6,740					*1,830	*1,830	5.76 m

SK210HLC		Boom: 2 piece boom		Arm: 3.5 m		Bucket: without		Shoe: 600 mm (Heavy Lift)		At Max. Reach		Radius				
A		1.5 m		3.0 m		4.5 m		6.0 m		7.5 m			9.0 m			
B																
9.0 m	kg					*5,760	*5,760							*4,040	*4,040	5.53 m
7.5 m	kg							*4,900	*4,900					*3,480	*3,480	7.09 m
6.0 m	kg							*5,910	5,510	*4,470	3,690			*3,250	3,180	8.07 m
4.5 m	kg					*6,920	*6,920	*6,890	5,260	*4,160	3,590			*3,190	2,720	8.69 m
3.0 m	kg	*27,470	*27,470	*15,760	14,850	*10,230	7,640	*7,820	4,890	*4,080	3,420	*3,350	2,480	*3,240	2,480	9.01 m
1.5 m	kg	*18,260	*18,260	*17,860	12,960	*11,290	6,860	7,450	4,520	*4,420	3,230	*3,910	2,410	*3,410	2,380	9.08 m
G.L.	kg	*19,140	*19,140	*6,710	*6,710	11,350	6,390	7,140	4,250	5,100	3,080			*3,720	2,400	8.89 m
-1.5 m	kg			*10,000	*10,000	*10,410	6,220	6,990	4,110	5,030	3,020			*4,230	2,580	8.43 m
-3.0 m	kg			*10,680	*10,680	*8,440	6,260	*6,400	4,120	*4,310	3,070			*4,010	3,000	7.65 m
-4.5 m	kg			*14,580	13,060	*5,140	*5,140	*4,510	4,330					*2,720	*2,720	6.43 m

SK210HLC		Boom: 2 piece boom Arm: 2.40 m Bucket: without Shoe: 600 mm (Heavy Lift)												
B \ A		1.5 m		3.0 m		4.5 m		6.0 m		7.5 m		At Max. Reach		Radius
9.0 m	kg											*7,980	*7,980	3.73 m
7.5 m	kg					*8,840	8,750					*6,070	5,530	5.80 m
6.0 m	kg					*9,010	8,550	*5,600	5,280			*5,140	4,000	6.97 m
4.5 m	kg			*14,160	*14,160	*10,120	7,970	*4,780	*4,780	*5,250	3,490	*4,730	3,330	7.68 m
3.0 m	kg			*15,820	14,220	*11,260	7,200	7,690	4,740	5,410	3,370	*4,590	3,000	8.05 m
1.5 m	kg			*17,910	12,820	11,600	6,610	7,360	4,450	5,260	3,240	*4,660	2,890	8.12 m
G.L.	kg	*25,340	*25,340	*15,680	12,390	*10,810	6,390	7,160	4,280	5,180	3,170	4,820	2,960	7.91 m
-1.5 m	kg			*9,830	*9,830	*9,070	6,390	*7,040	4,250			*4,820	3,270	7.39 m
-3.0 m	kg					*6,260	*6,260	*4,600	4,390			*3,560	*3,560	6.48 m

SK210HNLC		Boom: 2 piece boom Arm: 2.94 m Bucket: without Shoe: 600 mm (Heavy Lift)												
B \ A		1.5 m		3.0 m		4.5 m		6.0 m		7.5 m		At Max. Reach		Radius
9.0 m	kg					*5,890	*5,890					*4,940	*4,940	4.74 m
7.5 m	kg					*6,780	*6,780	*5,690	4,980			*4,050	*4,050	6.49 m
6.0 m	kg					*6,880	*6,880	*4,630	*4,630	*4,110	3,280	*3,710	3,230	7.55 m
4.5 m	kg			*10,470	*10,470	*9,190	7,470	*7,640	4,720	*4,830	3,240	*3,590	2,720	8.21 m
3.0 m	kg	*31,530	*31,530	*16,390	12,550	*10,820	6,710	7,760	4,380	*4,790	3,090	*3,620	2,460	8.55 m
1.5 m	kg			*17,880	11,090	*11,570	6,050	7,390	4,060	*5,150	2,940	*3,780	2,360	8.62 m
G.L.	kg	*19,960	*19,960	*14,880	10,710	*11,210	5,710	7,140	3,850	5,130	2,820	*4,120	2,410	8.42 m
-1.5 m	kg			*10,010	*10,010	*9,840	5,640	7,050	3,770	5,110	2,800	*4,700	2,620	7.93 m
-3.0 m	kg			*8,610	*8,610	*7,450	5,750	*5,650	3,830			*3,790	3,120	7.10 m
-4.5 m	kg			*11,930	11,750	*6,740	6,120					*1,830	*1,830	5.76 m

SK210HNLC		Boom: 2 piece boom Arm: 3.5 m Bucket: without Shoe: 600 mm (Heavy Lift)														
B \ A		1.5 m		3.0 m		4.5 m		6.0 m		7.5 m		9.0 m		At Max. Reach		Radius
9.0 m	kg					*5,760	*5,760							*4,040	*4,040	5.53 m
7.5 m	kg							*4,900	*4,900					*3,480	*3,480	7.09 m
6.0 m	kg							*5,910	5,060	*4,470	3,380			*3,250	2,900	8.07 m
4.5 m	kg					*6,920	*6,920	*6,890	4,810	*4,160	3,280			*3,190	2,470	8.69 m
3.0 m	kg	*27,470	*27,470	*15,760	13,170	*10,230	6,920	*7,820	4,450	*4,080	3,110	*3,350	2,240	*3,240	2,230	9.01 m
1.5 m	kg	*18,260	*18,260	*17,860	11,380	*11,290	6,170	7,440	4,090	*4,420	2,920	*3,910	2,170	*3,410	2,140	9.08 m
G.L.	kg	*19,140	*19,140	*6,710	*6,710	11,330	5,710	7,130	3,820	5,090	2,780			*3,720	2,160	8.89 m
-1.5 m	kg			*10,000	*10,000	*10,410	5,540	6,970	3,690	5,010	2,710			*4,230	2,320	8.43 m
-3.0 m	kg			*10,680	*10,680	*8,440	5,590	*6,400	3,700	*4,310	2,760			*4,010	2,700	7.65 m
-4.5 m	kg			*14,580	11,470	*5,140	*5,140	*4,510	3,900					*2,720	*2,720	6.43 m

SK210HNLC		Boom: 2 piece boom Arm: 2.40 m Bucket: without Shoe: 600 mm (Heavy Lift)												
B \ A		1.5 m		3.0 m		4.5 m		6.0 m		7.5 m		At Max. Reach		Radius
9.0 m	kg											*7,980	*7,980	3.73 m
7.5 m	kg					*8,840	8,010					*6,070	5,070	5.80 m
6.0 m	kg					*9,010	7,810	*5,600	4,830			*5,140	3,660	6.97 m
4.5 m	kg			*14,160	14,110	*10,120	7,250	*4,780	4,620	*5,250	3,170	*4,730	3,030	7.68 m
3.0 m	kg			*15,820	12,570	*11,260	6,500	7,670	4,310	5,390	3,060	*4,590	2,720	8.05 m
1.5 m	kg			*17,910	11,250	11,570	5,930	7,340	4,020	5,250	2,940	4,660	2,610	8.12 m
G.L.	kg	*25,340	*25,340	*15,680	10,840	*10,810	5,710	7,150	3,860	5,170	2,860	4,800	2,670	7.91 m
-1.5 m	kg			*9,830	*9,830	*9,070	5,720	*7,040	3,830			*4,820	2,960	7.39 m
-3.0 m	kg					*6,260	5,890	*4,600	3,970			*3,560	*3,560	6.48 m

Notes:

- Do not attempt to lift or hold any load that is greater than these lift capacities at their specified lift point radius and heights. Weight of all accessories must be deducted from the above lift capacities.
- Lift capacities are based on machine standing on level, firm, and uniform ground. User must make allowance for job conditions such as soft or uneven ground, out of level conditions, side loads, sudden stopping of loads, hazardous conditions, experience of personnel, etc.
- Arm top defined as lift point.
- The above lifting capacities are in compliance with ISO 10567. They do not exceed 87% of hydraulic lifting capacity or 75% of tipping load. Lifting capacities marked with an asterisk (*) are limited by hydraulic capacity rather than tipping load.
- Operator should be fully acquainted with the Operator's and Maintenance Instructions before operating this machine. Rules for safe operation of equipment should be adhered to at all times.
- Lift capacities apply to only machine as originally manufactured and normally equipped by KOBELCO CONSTRUCTION MACHINERY CO., LTD.

STANDARD EQUIPMENT

ENGINE

- HINO J05EVA-KSDM diesel engine with turbocharger and intercooler
- Automatic engine deceleration
- Auto Idle Stop (AIS)
- Batteries (2 x 12V - 96Ah)
- Starting motor (24V - 5kW), 60 amp alternator
- Automatic engine shut-down for low engine oil pressure
- Engine oil pan drain cock
- Double element air cleaner
- Refueling pump

CONTROL

- Working mode selector (H-mode, S-mode and ECO-mode)
- Power Boost
- Heavy lift
- Object Handling Kit (boom and arm safety valve + hook)
- Extra N&B piping (proportional hand controlled)

SWING SYSTEM & TRAVEL SYSTEM

- Straight propel system
- Two-speed travel with automatic shift down
- Sealed & lubricated track links
- Grease-type track adjusters
- Automatic swing brake

HYDRAULIC

- Arm regeneration system
- Auto warm up system
- Aluminum hydraulic oil cooler
- Hydraulic fluid filter clog detector
- Hydraulic pressure adjustment function for N&B piping
- Quick hitch piping

MIRRORS, LIGHTS & CAMERAS

- Rearview mirror
- Three front working lights
- Rear & right side cameras

CAB & CONTROL

- Two control levers, pilot-operated
 - Horn, electric
 - Cab light (interior)
 - Luggage tray
 - Large cup holder
 - Detachable two-piece floor mat
 - Headrest
 - Handrails
 - Intermittent windshield wiper with double-spray washer
 - Skylight
 - Tinted safety glass
 - Pull-up type front window and removable lower front window
 - Easy-to-read multi-display color monitor
 - Emergency escape hammer
 - Air suspension seat with heater (Optional for N&B piping specification)
 - Radio, AM/FM stereo with speaker
 - USB pin
 - Top guard (ISO 10262 : 1998)
 - Remote machine monitoring system "KOMEXS"
 - Tow eyes
 - Automatic air conditioner
- The air conditioning system on this machine contains fluorinated greenhouse gas HFC-134a (GWP 1430).
Quantity of gas 0.8 kg (CO₂ equivalent 1.2 t)

OPTIONAL EQUIPMENT

- Various optional arms
- Wide range of shoes
- Additional track guide
- Two cab lights
- Extended guard rail
- Rain visor (may interfere with bucket action)
- Cab guard
- Travel alarm
- Lower Under Cover
- Bigger capacity P4 pump and steel PTO housing

Note: Standard and optional equipment may vary. Consult your KOBELCO dealer for specifics.

Note: This catalogue may contain attachments and optional equipment that are not available in your area. And it may contain photographs of machines with specifications that differ from those of machines sold in your areas. Please consult your nearest KOBELCO distributor for those items you require. Specialist equipment is needed to use this machine in demolition work. Before using it please contact your KOBELCO dealer. Due to our policy of continuous product improvements all designs and specifications are subject to change without advance notice. Copyright by **KOBELCO CONSTRUCTION MACHINERY CO., LTD.** No part of this catalogue may be reproduced in any manner without notice.

KOBELCO CONSTRUCTION MACHINERY EUROPE B.V.

Veluwezoom 15
1327 AE Almere
The Netherlands
www.kobelco-europe.com

Enquiries To: